

TV 1800

- 1 - Tapón
Tomada
Plugs
Tappi - no. 3 pz.
- 2 - Purgador
Purgador
Air vent
Valvola di sfiato - no. 1 pz.
- 3 - Soportes
Apoio
Brachets
Mensole - no. 3 pz.
- 4 - Diafragma
Diafragma
Flow divertor
Diaframma - no. 1 pz.

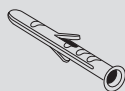

3

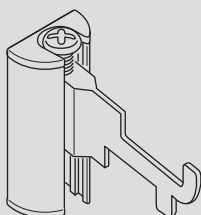

4

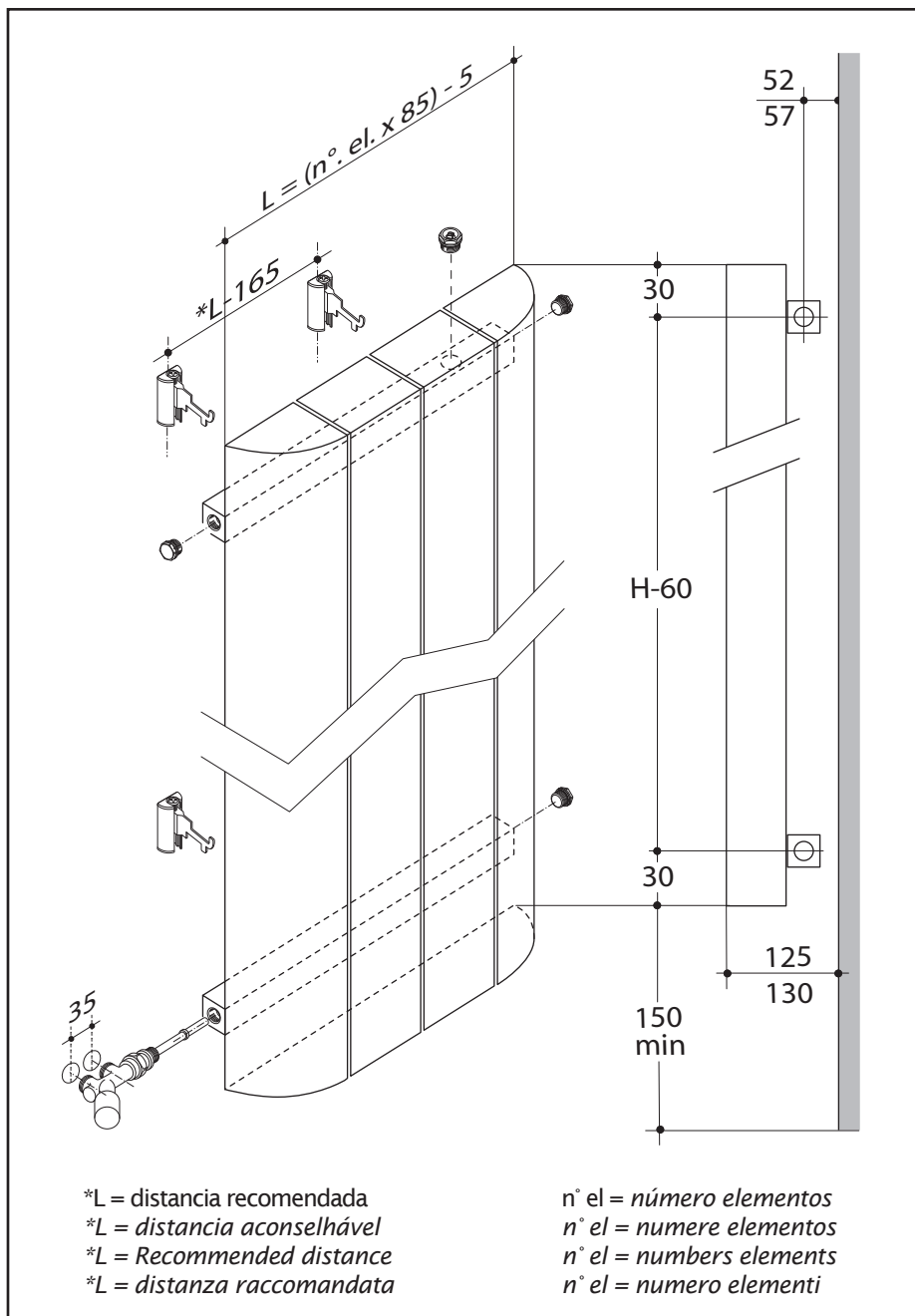

Montaje del la vlvula
Assembleia da valvula
Assembly the valve
Montaggio della valvola

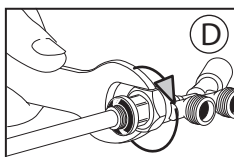
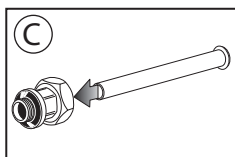
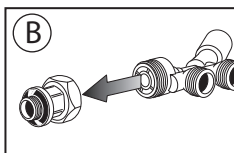
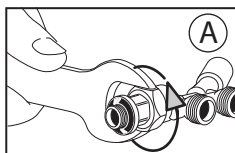

Montaje del diafragma
Assembleia do diafragma
Assembly the flow divertor
Montaggio del diaframma

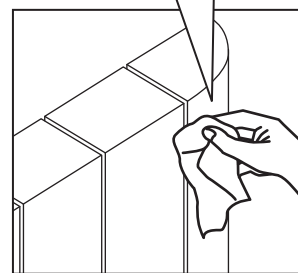
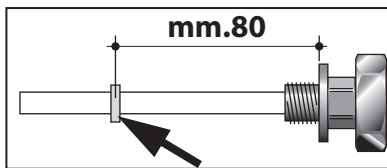
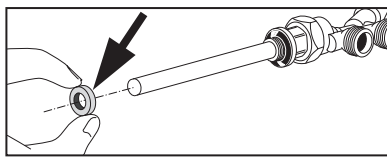

Conexiones standard:
Conexoes standard:
Standard connections:
Connessione standard:

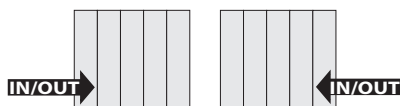

Con vlvula monotubo y diafragma (4)
Com valvula monotubo y diafragma (4)
With valve monotube and flow divertor(4)
Con valvula monotubo e diaframma (4)

TV 1800

- 1 - Tapón
Tomada
Plugs
Tappi - no. 3 pz.
- 2 - Purgador
Purgador
Air vent
Valvola di sfiato - no. 1 pz.
- 3 - Soportes
Apoio
Brachets
Mensole - no. 3 pz.
- 4 - Diafragma
Diafragma
Flow divertor
Diaframma - no. 1 pz.

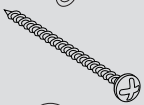
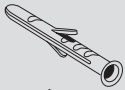

3

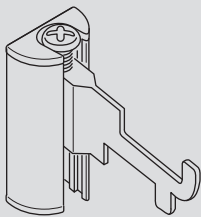

4

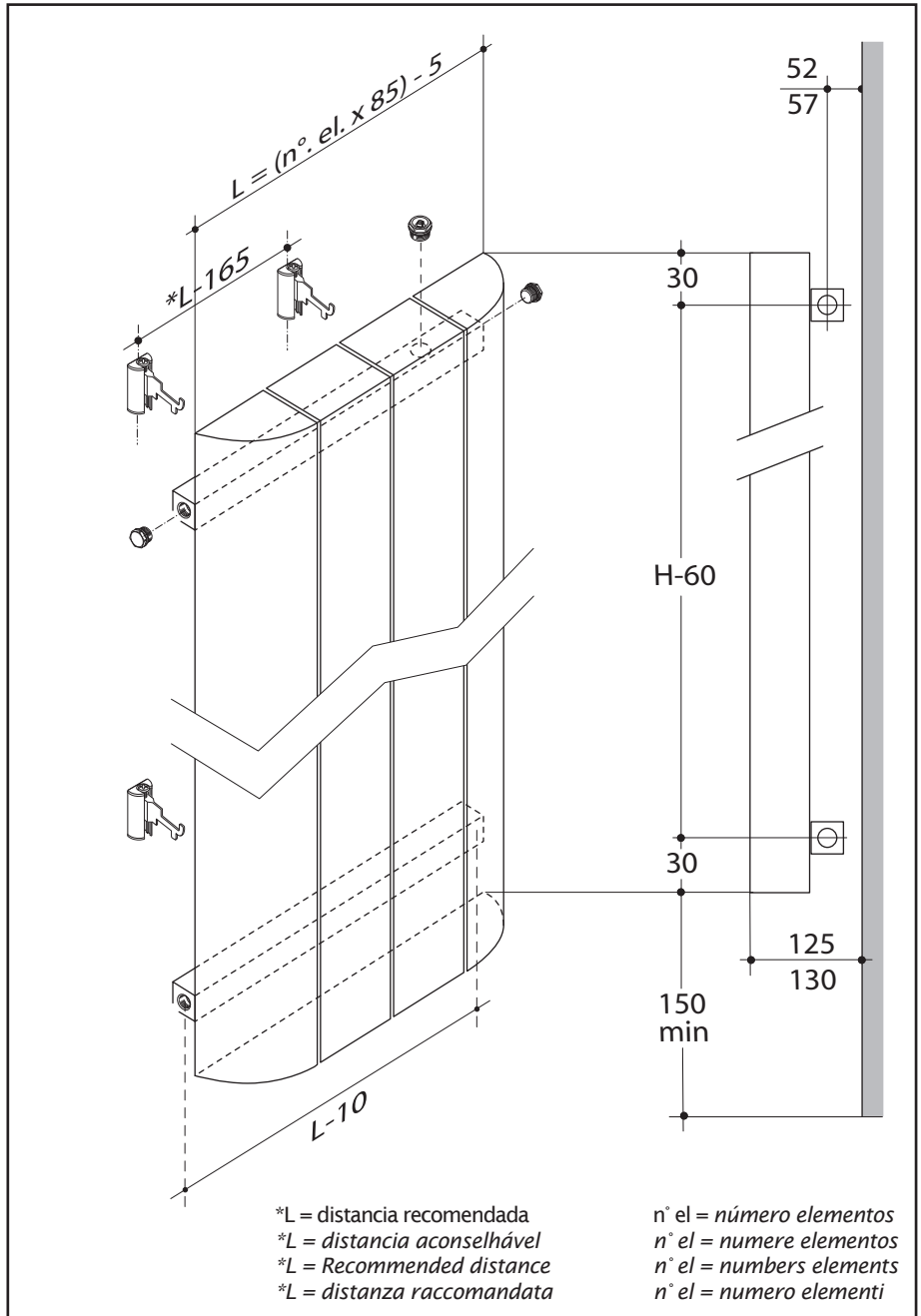

Conexiones 120 - 320, con diafragma

Conexões 120 - 320, com diafragma

Connections 120 - 320 with flow divertor

Connessione 120 - 320 con diaframma

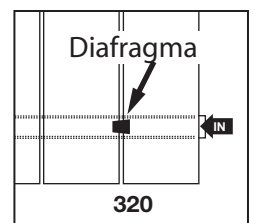
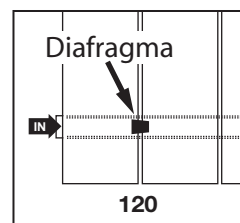

Conexiones 100 - 300 - 110 - 310 - 180 - 380, sin diafragma

Conexões 100 - 300 - 110 - 310 - 180 - 380, sem diafragma

Connections 100 - 300 - 110 - 310 - 180 - 380 without flow divertor

Connessione 100 - 300 - 110 - 310 - 180 - 380 senza diaframma

